

1 x 700326

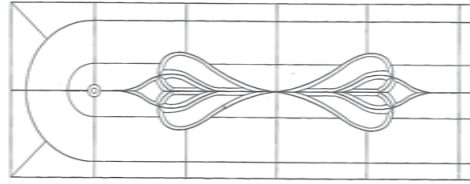

2 x 700334
1 x 700060

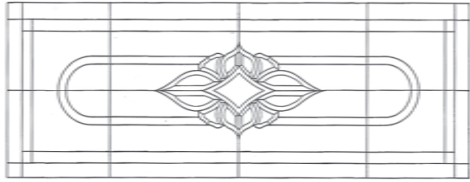

1 x 700320

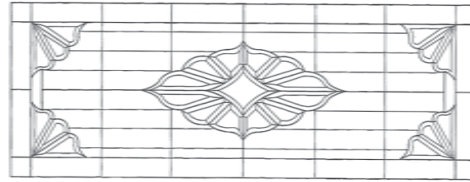

1 x 700322
4 x 700452

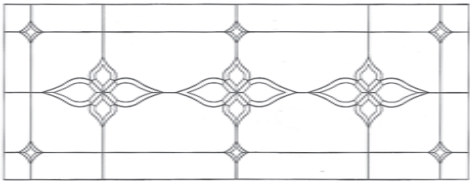

3 x 700303
6 x 700567

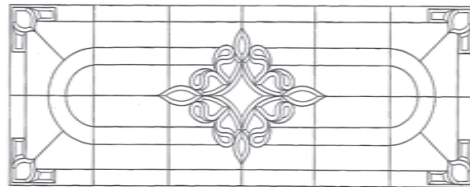

1 x 700323
4 x 700457

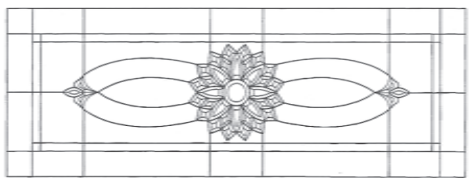

1 x 700440
2 x 700406

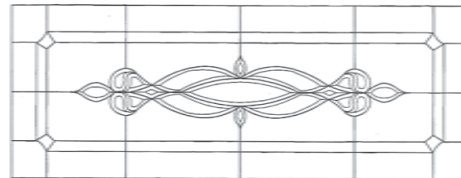

1 x 700349

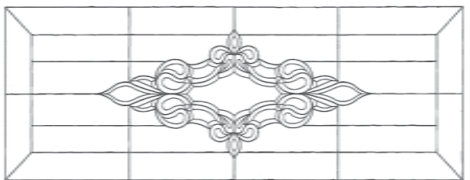

1 x 700338

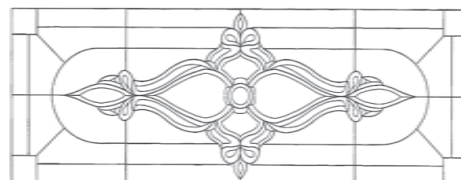

1 x 700352

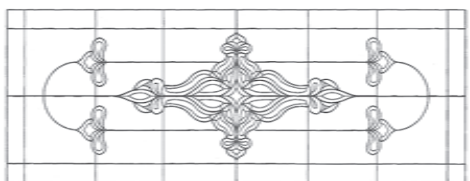

1 x 700336
4 x 700401

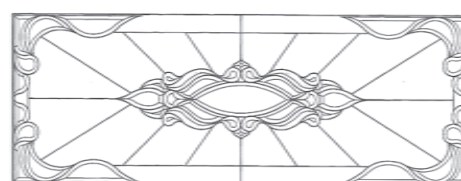

1 x 700343
2 x 700465
2 x 700466

Biseles de espejo y de vidrio
Bevels
Facetten - Vorschläge

Biseles de espejo y de vidrio
Bevels

Facetten - Vorschläge

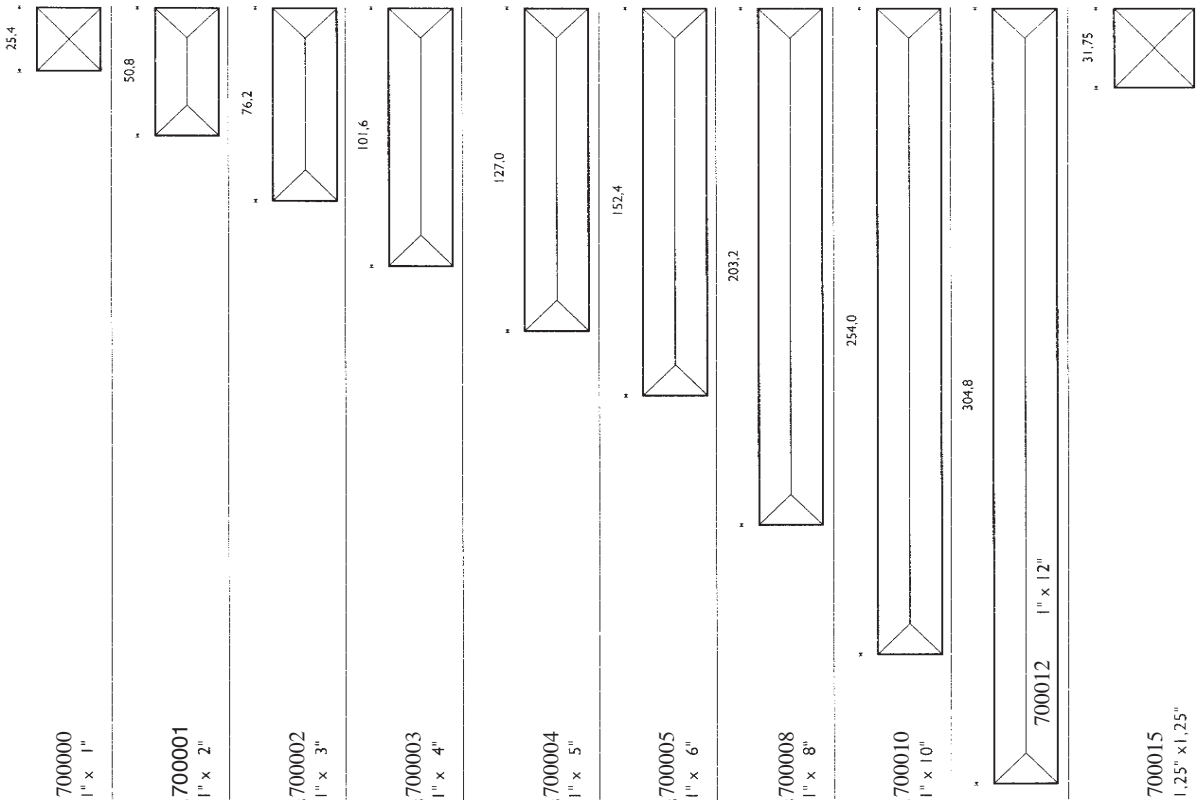

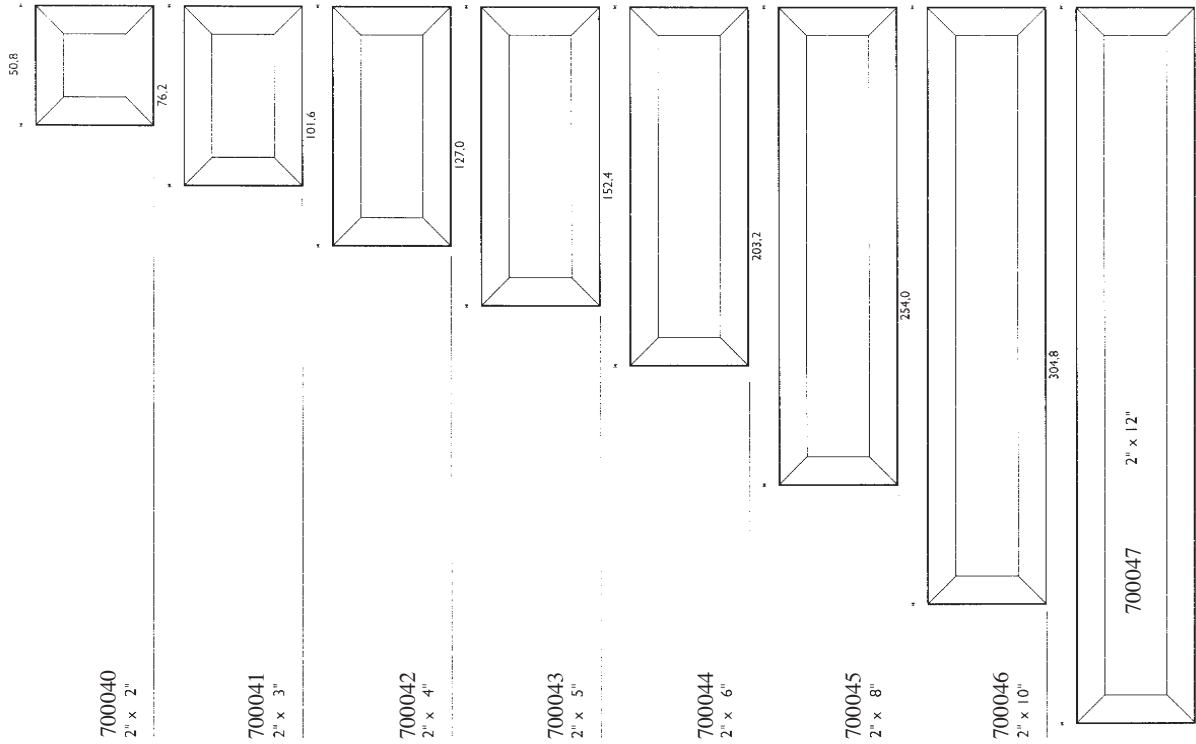
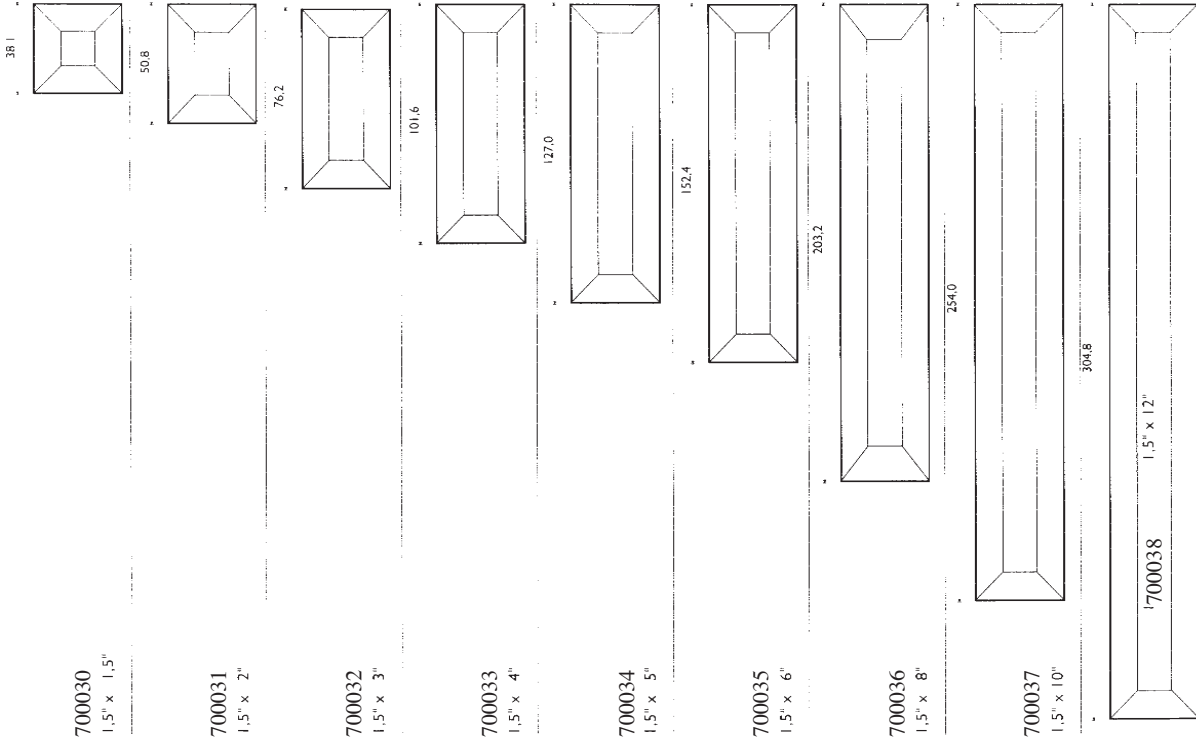

Facetten Biseles de espejo y de vidrio
Bevels

Facetten Bevels

Biseles de espejo y de vidrio

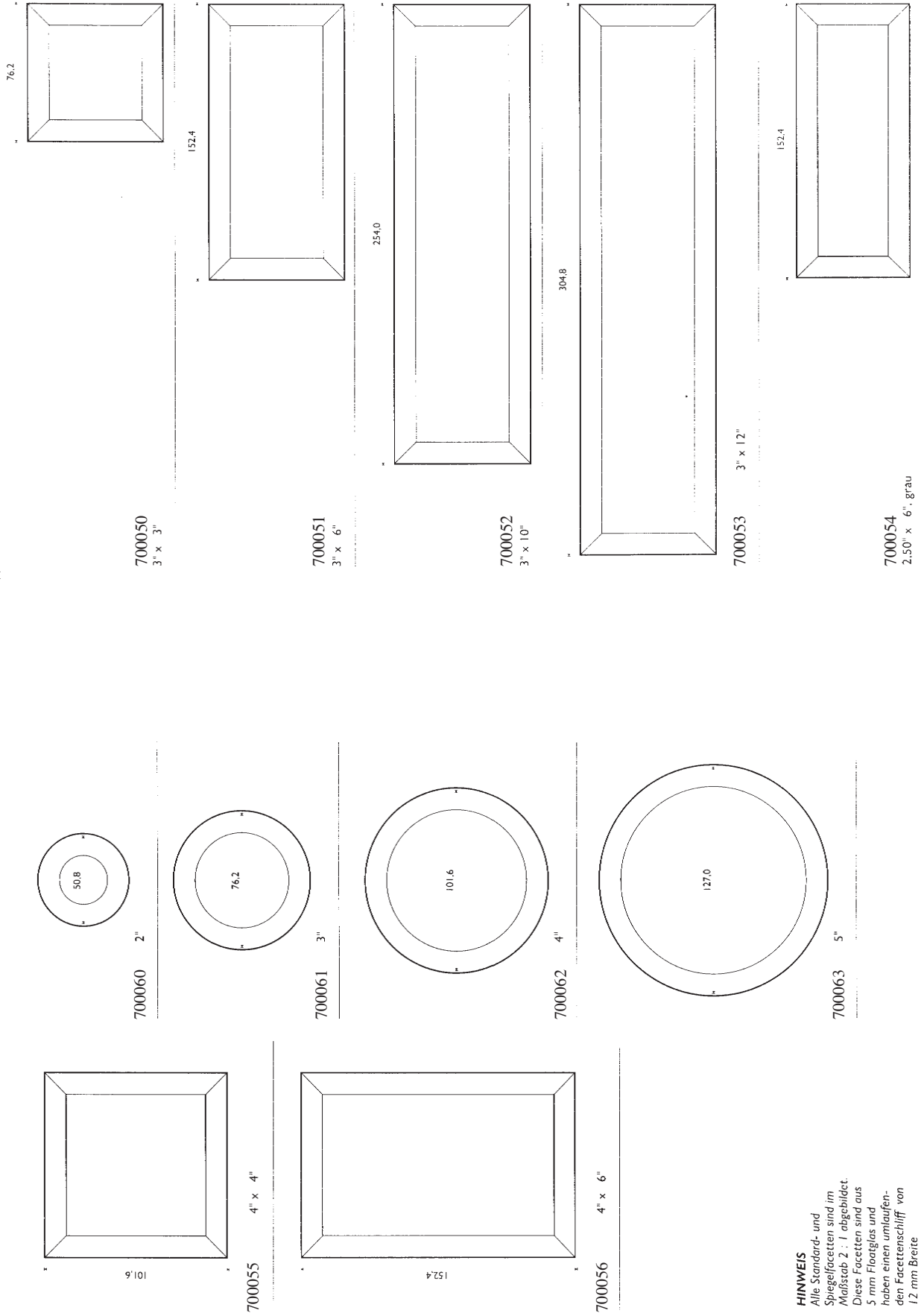

HINWEIS
Alle Standard- und Spiegelfacetten sind im Maßstab 2 : 1 abgebildet. Diese Facetten sind aus 5 mm Floatglas und haben einen umlaufenden Facettenschliff von 12 mm Breite

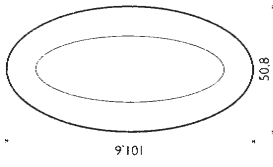

2" x 4"

700067

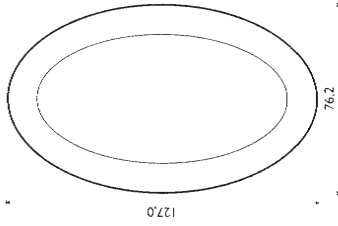

3" x 5"

700068

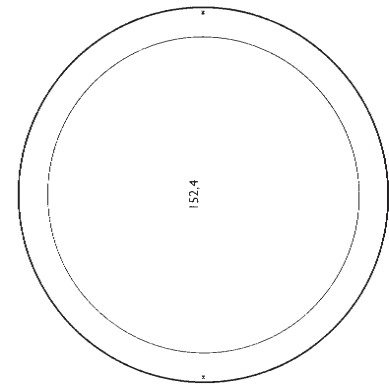

6"

700064

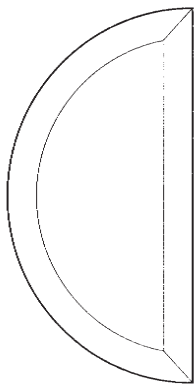

6"

700065

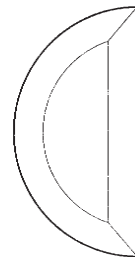

4"

700066

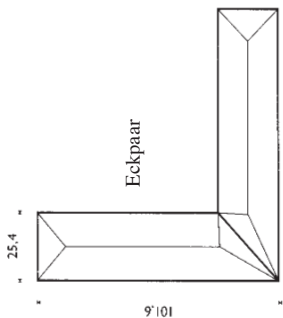

Eckpaar

1" x 4" x 4"

700080

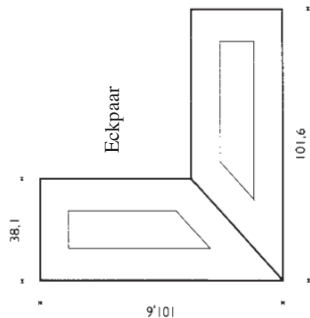

Eckpaar

1,5" x 4" x 4"

700081

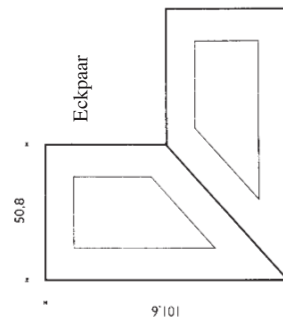

Eckpaar

2" x 4" x 4"

700082

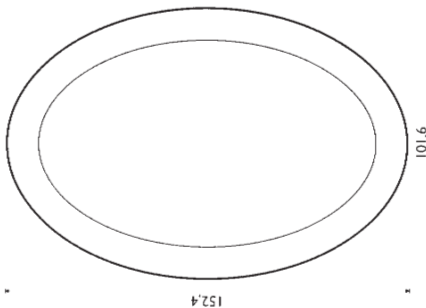

4" x 6"

700069

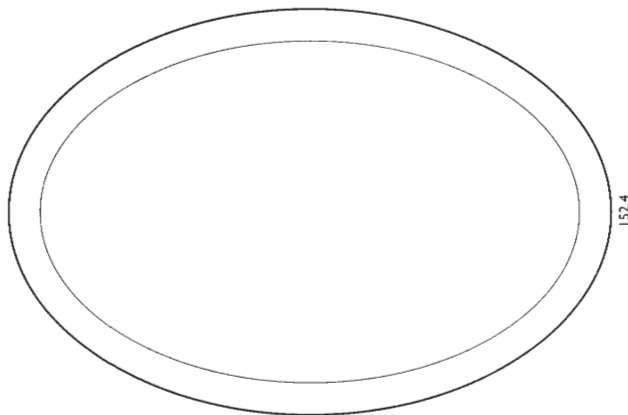

6" x 9"

700070

Umrechnung der
Zollmaße in Millimeter:

- 1 Zoll = 25,4 mm
- 2 Zoll = 50,8 mm
- 3 Zoll = 76,2 mm
- 4 Zoll = 101,6 mm
- 5 Zoll = 127,0 mm
- 6 Zoll = 152,4 mm
- 7 Zoll = 177,8 mm
- 8 Zoll = 203,2 mm
- 9 Zoll = 228,6 mm
- 10 Zoll = 254,0 mm
- 11 Zoll = 279,4 mm
- 12 Zoll = 304,8 mm

HINWEIS

Alle Standard- und Spiegelfacetten sind im Maßstab 2 : 1 abgebildet. Diese Facetten sind aus 5 mm Floatglas und haben einen umlaufenden Facettenschliff von 12 mm Breite

Biseles de espejo y de vidrio
Bevels
Facetten

Facetten
Biseles de espejo y de vidrio
Bevels

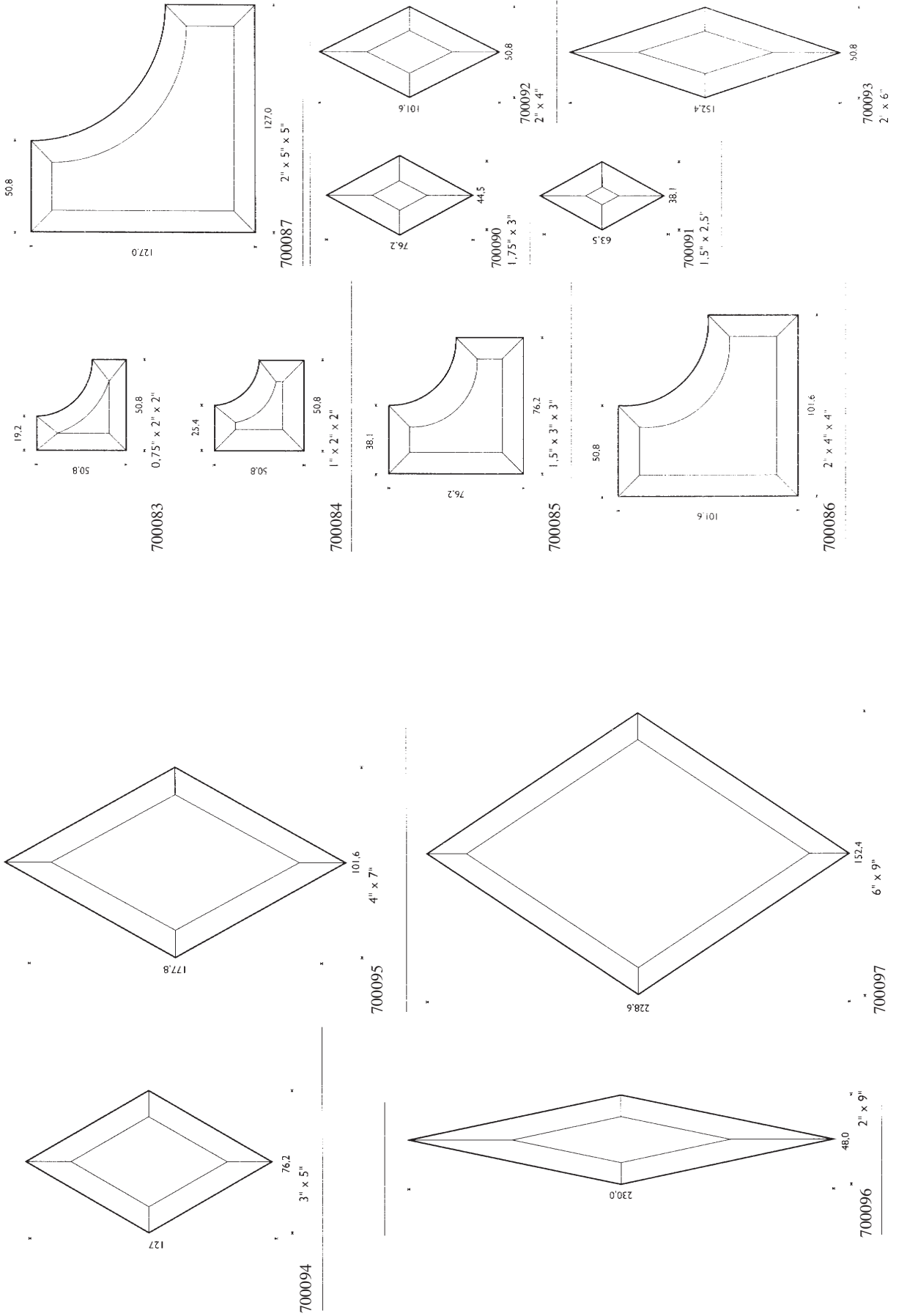

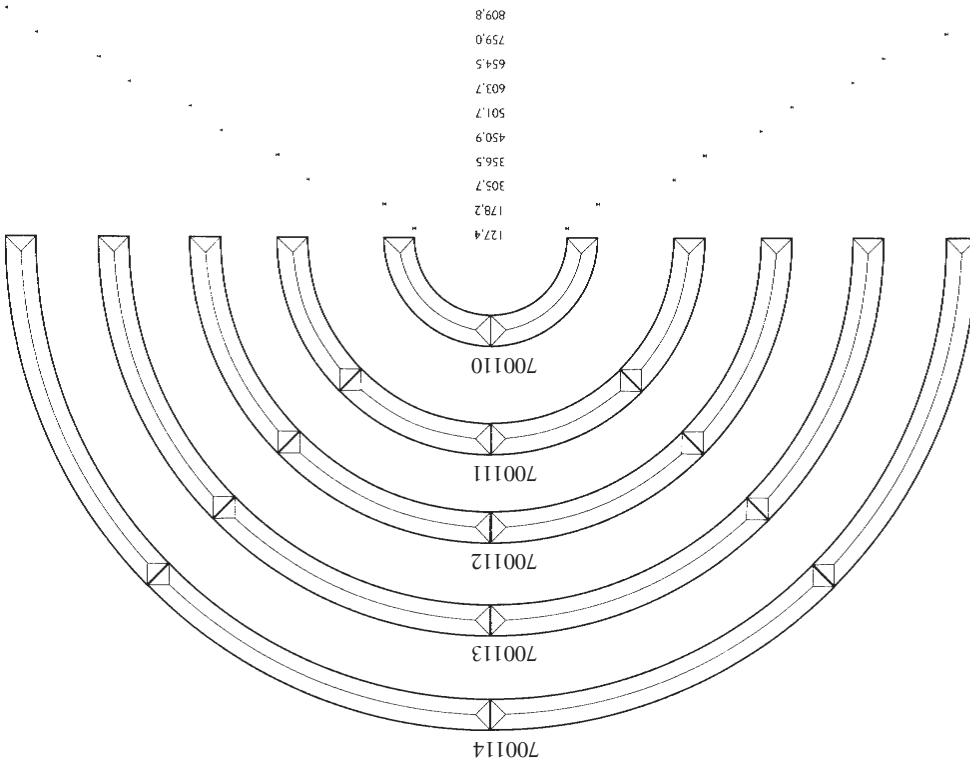

! Maßstab 4 : 1 !

85 288 02	Set = 2 Stück	85 288 09	Set = 4 Stück	85 288 15	Set = 4 Stück
Außen-Ø = 178,2 mm		Außen-Ø = 501,7 mm		Außen-Ø = 809,8 mm	
Innen-Ø = 127,4 mm		Innen-Ø = 450,9 mm		Innen-Ø = 759,0 mm	
85 288 06	Set = 4 Stück	85 288 12	Set = 4 Stück		
Außen-Ø = 356,5 mm		Außen-Ø = 603,7 mm			
Innen-Ø = 305,7 mm		Innen-Ø = 501,7 mm			

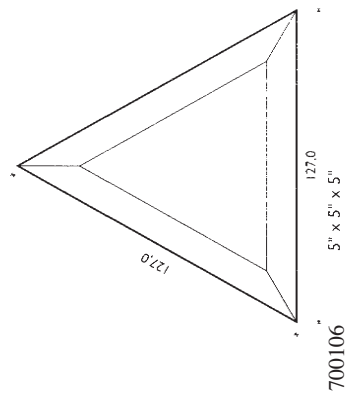
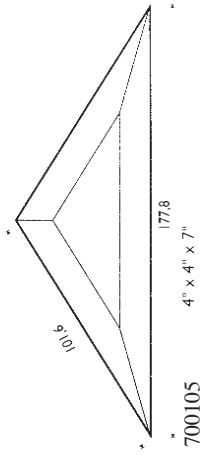
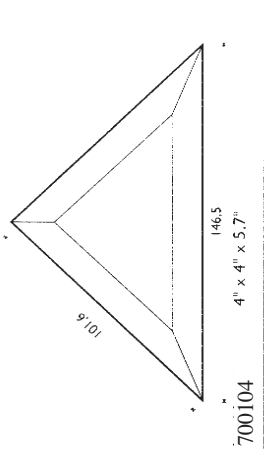
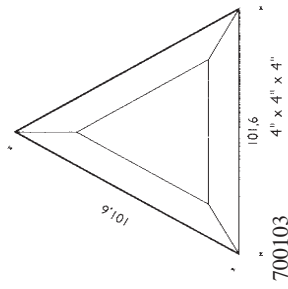
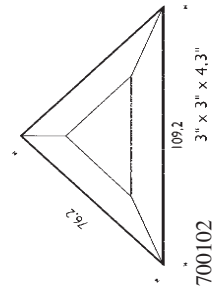
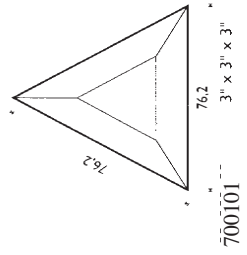
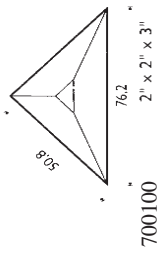

HINWEIS
 Alle Standard- und Spiegelfacetten sind im Maßstab 2 : 1 abgebildet. Diese Facetten sind aus 5 mm Floatglas und haben einen umlaufenden Facettenschliff von 1,2 mm Breite.

Facetten - Spiegel

Biseles de espejo

Facetten mirror

Facetten - Spiegel

Biseles de espejo

Facetten mirror

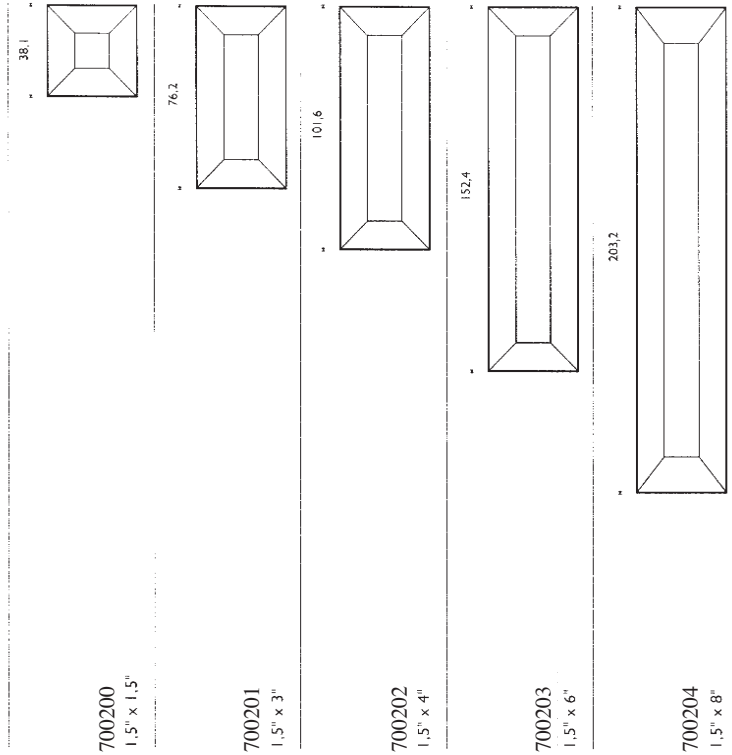

Umrechnung der Zollmaße in Millimeter:

- 1 Zoll = 25,4 mm
- 2 Zoll = 50,8 mm
- 3 Zoll = 76,2 mm
- 4 Zoll = 101,6 mm
- 5 Zoll = 127,0 mm
- 6 Zoll = 152,4 mm
- 7 Zoll = 177,8 mm
- 8 Zoll = 203,2 mm
- 9 Zoll = 228,6 mm
- 10 Zoll = 254,0 mm
- 11 Zoll = 279,4 mm
- 12 Zoll = 304,8 mm

HINWEIS

Alle Standard- und Spiegelfacetten sind im Maßstab 2 : 1 abgebildet.
Diese Facetten sind aus 5 mm Floatglas und haben einen umlaufenden Facettenschliff von 12 mm Breite

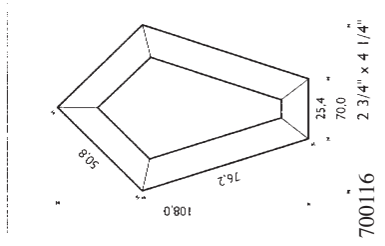

Die VE beträgt 30 Stück.

Umrechnung der Zollmaße in Millimeter:

- 1 Zoll = 25,4 mm
- 2 Zoll = 50,8 mm
- 3 Zoll = 76,2 mm
- 4 Zoll = 101,6 mm
- 5 Zoll = 127,0 mm
- 6 Zoll = 152,4 mm
- 7 Zoll = 177,8 mm
- 8 Zoll = 203,2 mm
- 9 Zoll = 228,6 mm
- 10 Zoll = 254,0 mm
- 11 Zoll = 279,4 mm
- 12 Zoll = 304,8 mm

HINWEIS

Alle Standard- und Spiegelfacetten sind im Maßstab 2 : 1 abgebildet.
Diese Facetten sind aus 5 mm Floatglas und haben einen umlaufenden Facettenschliff von 12 mm Breite

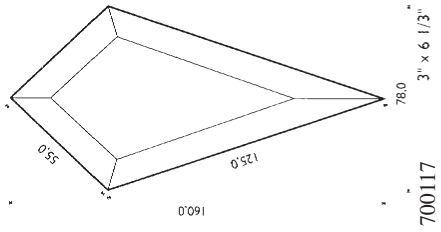
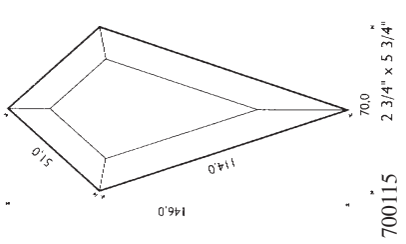

Biseles de espejo
Facetten mirror

Facetten - Spiegel

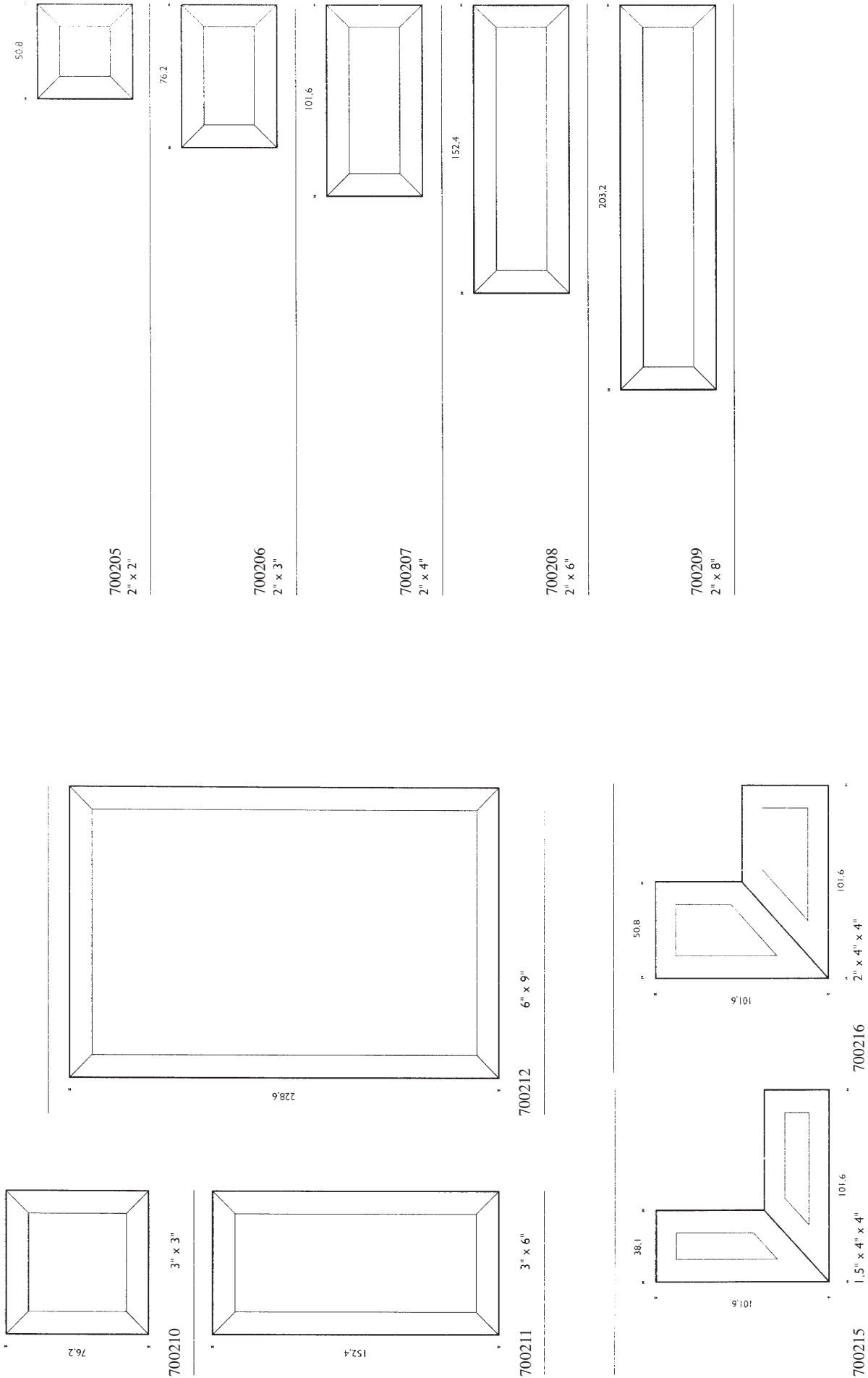

Facetten Bevels

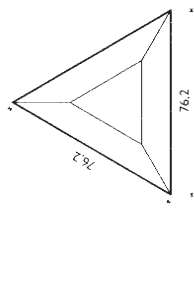

700230

3" x 3" x 3"

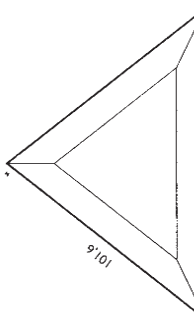

700232

4" x 4" x 5"

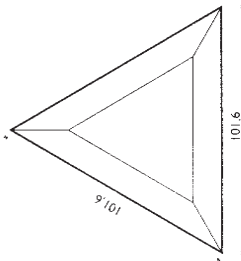

700231

4" x 4" x 4"

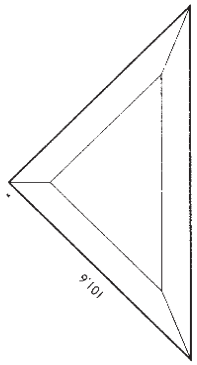

700233

4" x 4" x 5.7"

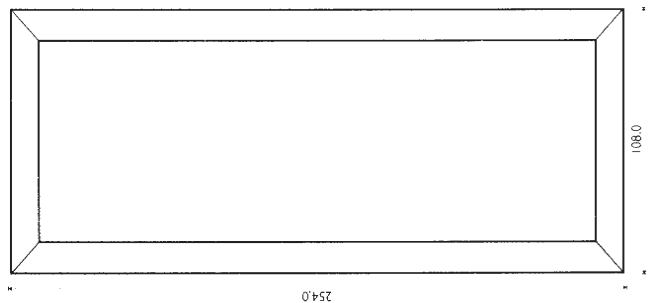

700243

10" x 4.25"

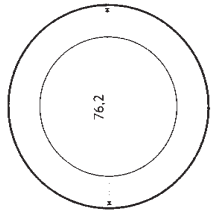

700217

Ø 3"

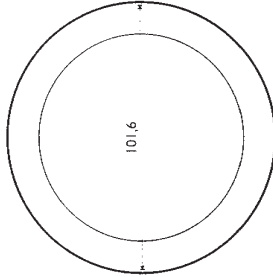

700218

Ø 4"

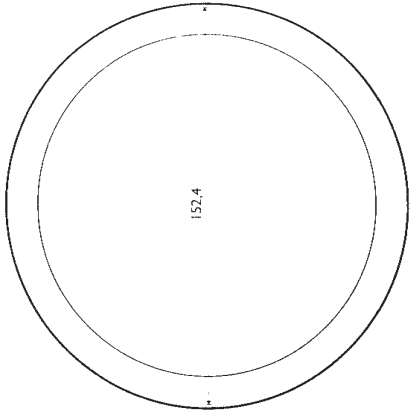

700220

Ø 6"

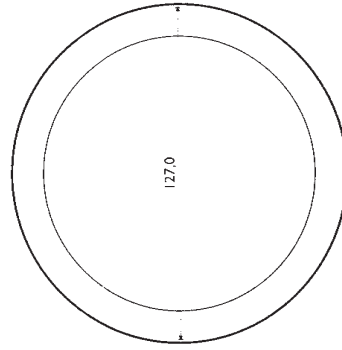

700219

Ø 5"

Umrechnung der
Zollmaße in Millimeter:

- 1 Zoll = 25,4 mm
- 2 Zoll = 50,8 mm
- 3 Zoll = 76,2 mm
- 4 Zoll = 101,6 mm
- 5 Zoll = 127,0 mm
- 6 Zoll = 152,4 mm
- 7 Zoll = 177,8 mm
- 8 Zoll = 203,2 mm
- 9 Zoll = 228,6 mm
- 10 Zoll = 254,0 mm
- 11 Zoll = 279,4 mm
- 12 Zoll = 304,8 mm

HINWEIS

Alle Standard- und
Spiegelfacetten sind im
Maßstab 2 : 1 abgebildet.
Diese Facetten sind aus
5 mm Floatglas und
haben einen umlaufenden
Facettenschliff von
12 mm Breite

Umrechnung der
Zollmaße in Millimeter:

- 1 Zoll = 25,4 mm
- 2 Zoll = 50,8 mm
- 3 Zoll = 76,2 mm
- 4 Zoll = 101,6 mm
- 5 Zoll = 127,0 mm
- 6 Zoll = 152,4 mm

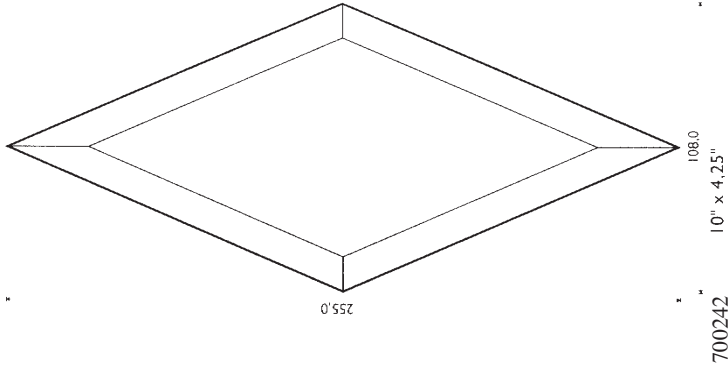
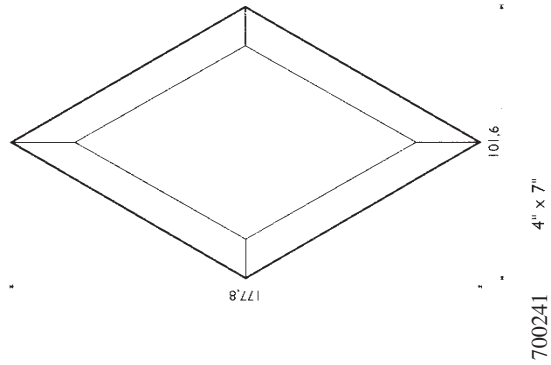
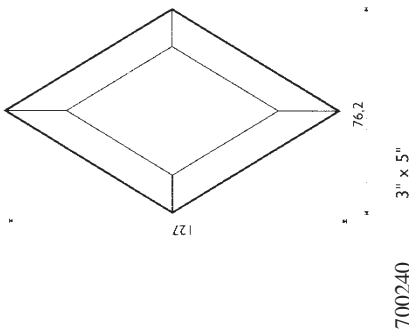
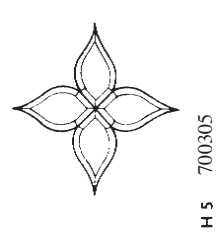
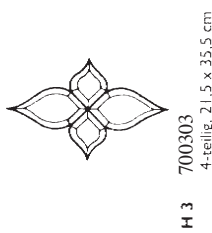
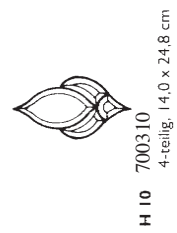
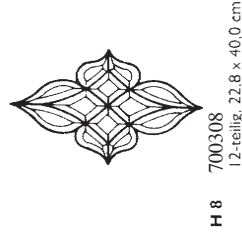
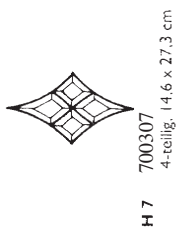
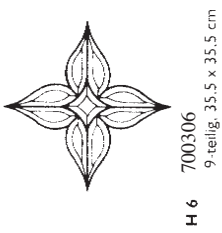
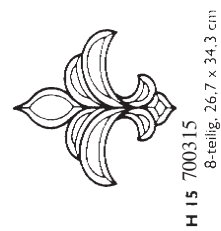
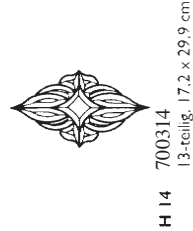
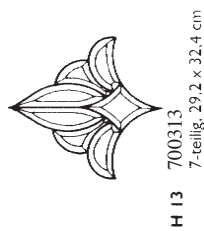

HINWEIS

Alle Standard- und Spiegelfacetten sind im Maßstab 2 : 1 abgebildet. Diese Facetten sind aus 5 mm Floatglas und haben einen umlaufenden Facettenschliff von 1,2 mm Breite

Facetten
Biseles de espejo y de vidrio
Bevels

Facetten
Biseles de espejo y de vidrio
Bevels

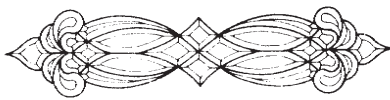

H 25 700325
28-teilig, 19,7 x 83,8 cm

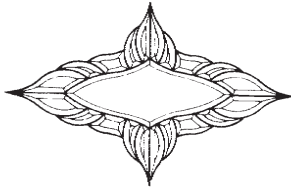

H 28 700328
21-teilig, 40,6 x 63,5 cm

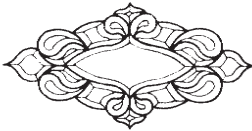

H 30 700330
21-teilig, 29,8 x 54,6 cm



H 30B 700331
21-teilig, 22,3 x 54,6 cm

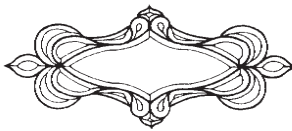

H 29 700329
21-teilig, 28,0 x 62,8 cm



H 29B 700329,2
21-teilig, 21,7 x 66,6 cm

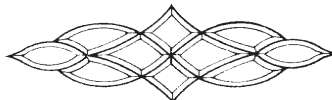

H 26 700326
10-teilig, 20,9 x 71,1 cm

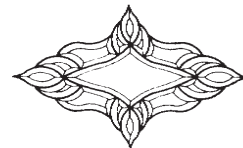

H 27 700327
17-teilig, 30,5 x 51,5 cm



H 16 700316
10-teilig, 32,4 x 19,7 cm



H 17 700317
11-teilig, 42,5 x 17,8 cm

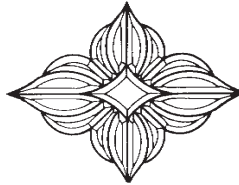

H 18 700318
17-teilig, 38,1 x 48,3 cm

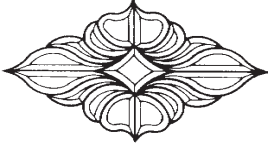

H 20 700320
17-teilig, 29,2 x 53,3 cm

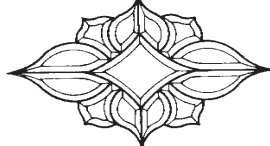

H 21 700321
13-teilig, 30,5 x 53,3 cm

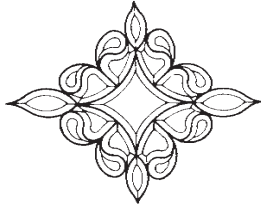

H 23 700323
21-teilig, 40,6 x 52,0 cm



H 24 700324
27-teilig, 23,5 x 81,3 cm

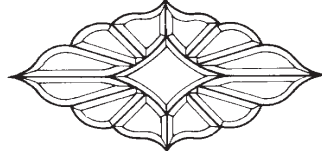

H 22 700322
13-teilig, 30,5 x 62,2 cm

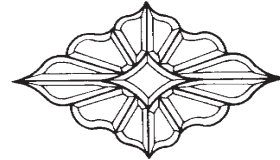

H 19 700319
13-teilig, 31,1 x 53,3 cm

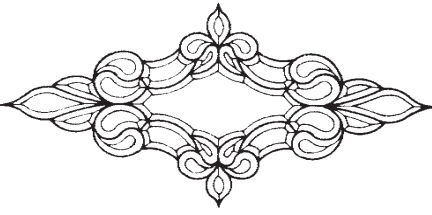

H 36 700338
29-teilig, 40,6 x 86,3 cm

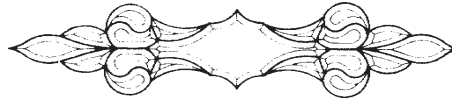

H 36B 700339
19-teilig, 18,4 x 86,3 cm

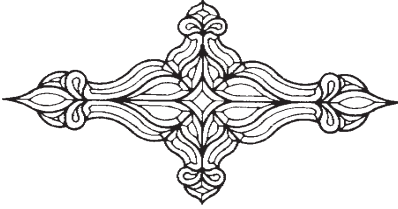

H 34 700336
33-teilig, 39,3 x 78,1 cm



H 35 700337
28-teilig, 22,8 x 78,1 cm



H 31B 700333
19-teilig, 20,3 x 68,6 cm

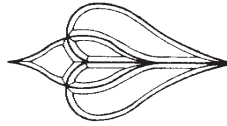

H 32 700334
5-teilig, 24,1 x 45,7 cm

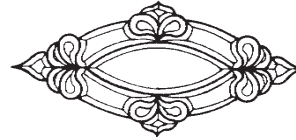

H 33 700335
21-teilig, 26,7 x 58,4 cm

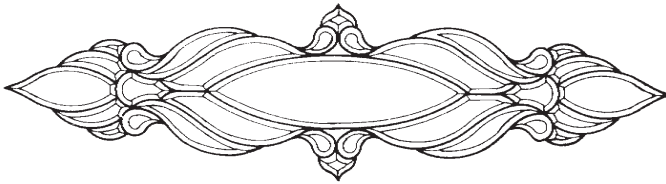

H 40 700344
31-teilig, 36,8 x 138,4 cm

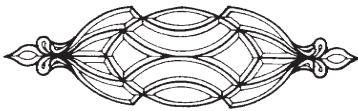

H 38 700342
24-teilig, 20,9 x 74,3 cm

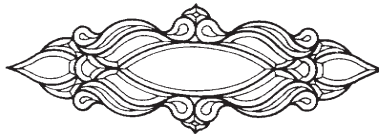

H 39 700343
27-teilig, 25,7 x 76,8 cm

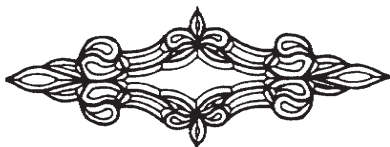

H 36C 700340
29-teilig, 28,6 x 82,6 cm

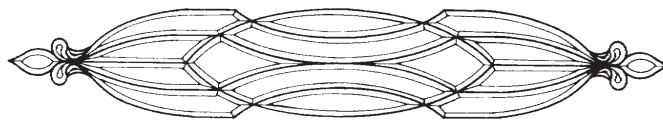

H 37 700341
24-teilig, 17,1 x 136,8 cm

Facetten
Biseles de espejo y de vidrio
Bevels

Facetten
Biseles de espejo y de vidrio
Bevels

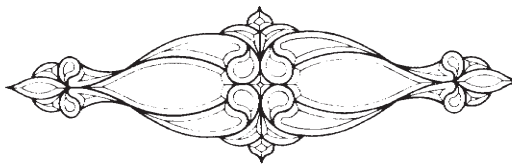

H 45 700350
31-teilig, 31,8 x 106,7 cm

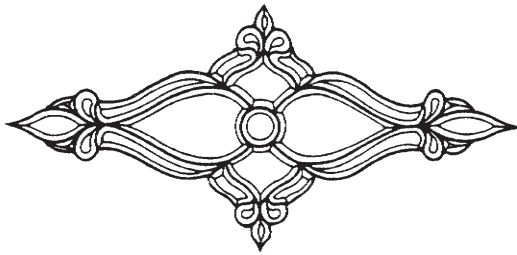

H 47 700352
29-teilig, 50,8 x 106,7 cm

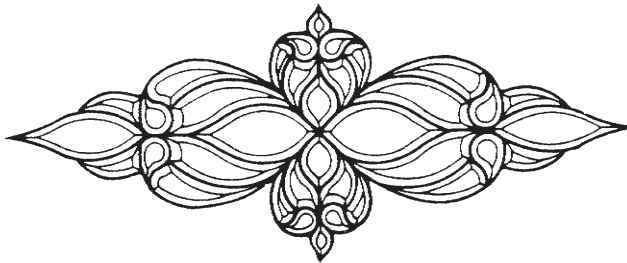

H 48 700354
36-teilig, 52,0 x 129,6 cm

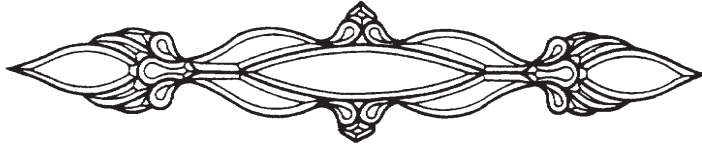

H 40B 700345
27-teilig, 28,6 x 137,0 cm

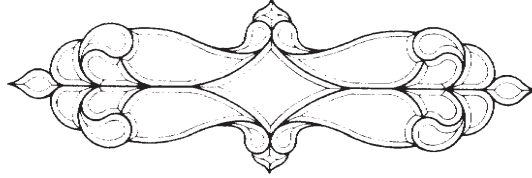

H 41 700346
25-teilig, 34,5 x 106,7 cm

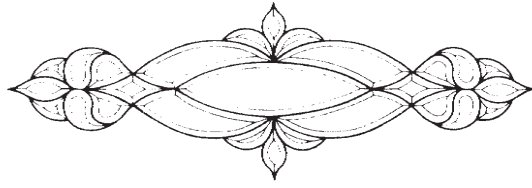

H 43 700348
27-teilig, 34,9 x 106,7 cm

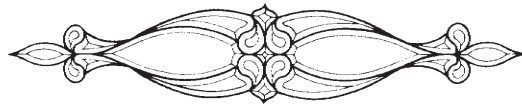

H 46 700351
23-teilig, 20,8 x 106,7 cm

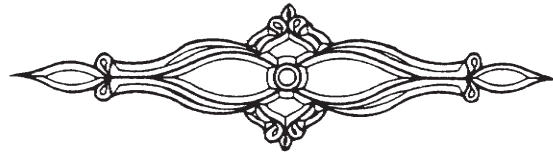

H 47B 700353
25-teilig, 31,1 x 115,6 cm

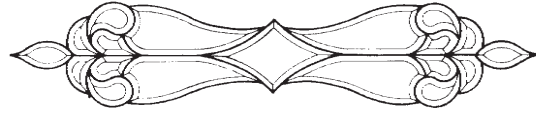

H 42 700347
19-teilig, 20,9 x 106,7 cm

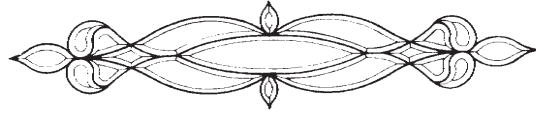

H 44 700349
19-teilig, 20,3 x 106,7 cm

HINWEIS

Die H- und die HS-Bevels sind ca. im Maßstab 10 : 1 abgebildet. Sie bestehen aus 5 mm Floatglas und haben einen umlaufenden Facettenschliff von 12 mm.

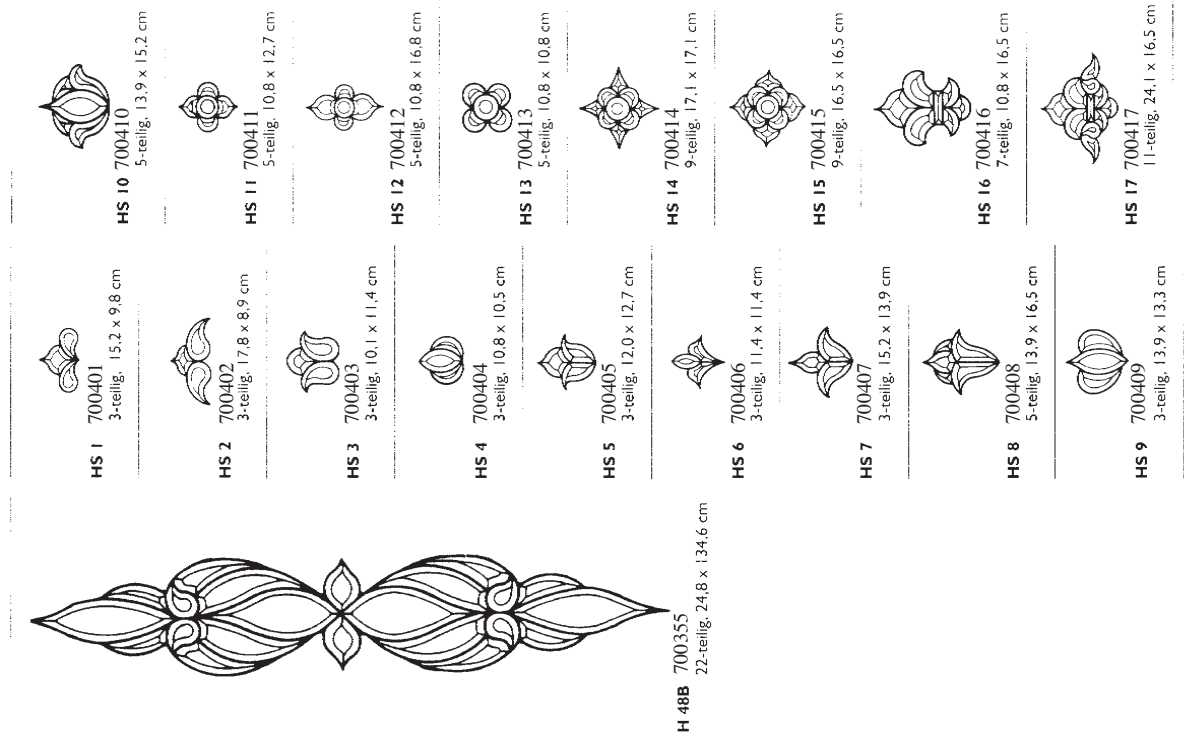

H 488 700355
22-teilig, 24,8 x 134,6 cm

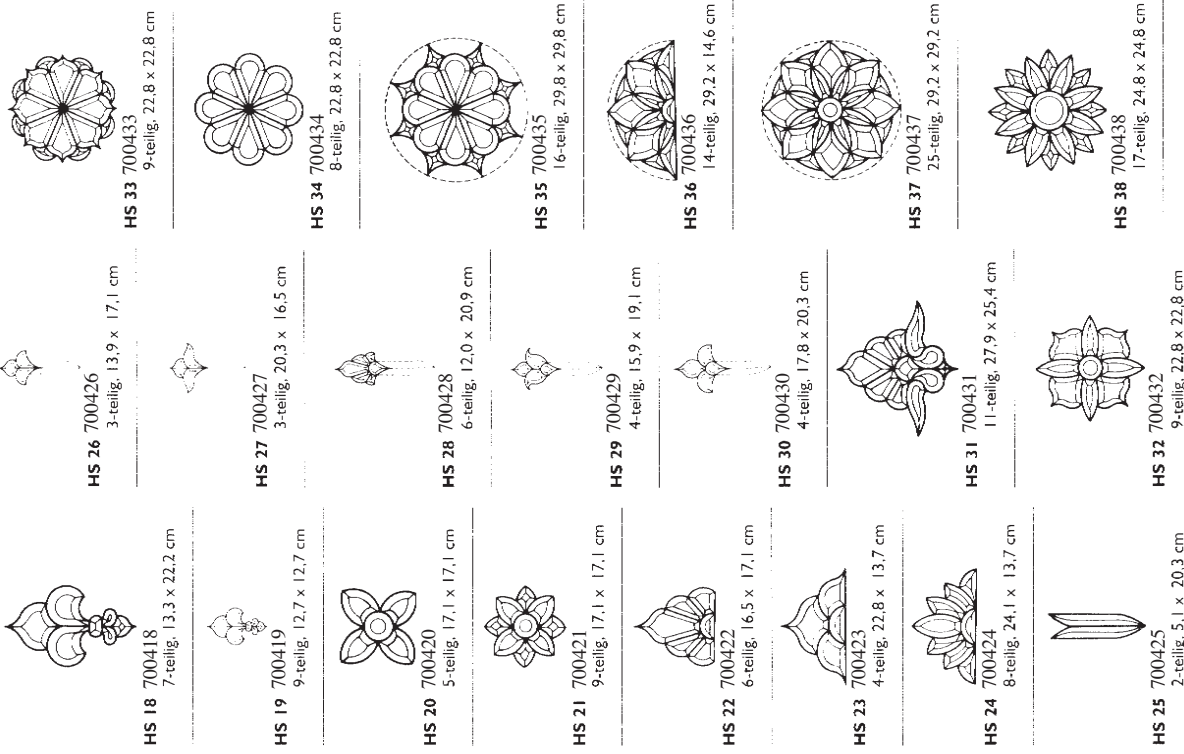

HS 18 700418
7-teilig, 13,3 x 22,2 cm

HS 19 700419
9-teilig, 12,7 x 12,7 cm

HS 20 700420
5-teilig, 17,1 x 17,1 cm

HS 21 700421
9-teilig, 17,1 x 17,1 cm

HS 22 700422
6-teilig, 16,5 x 17,1 cm

HS 23 700423
4-teilig, 22,8 x 13,7 cm

HS 24 700424
8-teilig, 24,1 x 13,7 cm

HS 25 700425
2-teilig, 5,1 x 20,3 cm

HS 26 700426
3-teilig, 13,9 x 17,1 cm

HS 27 700427
3-teilig, 20,3 x 16,5 cm

HS 28 700428
6-teilig, 12,0 x 20,9 cm

HS 29 700429
4-teilig, 15,9 x 19,1 cm

HS 30 700430
4-teilig, 17,8 x 20,3 cm

HS 31 700431
11-teilig, 27,9 x 25,4 cm

HS 32 700432
9-teilig, 22,8 x 22,8 cm

HS 33 700433
9-teilig, 22,8 x 22,8 cm

HS 34 700434
8-teilig, 22,8 x 22,8 cm

HS 35 700435
16-teilig, 29,8 x 29,8 cm

HS 36 700436
14-teilig, 29,2 x 14,6 cm

HS 37 700437
25-teilig, 29,2 x 29,2 cm

HS 38 700438
17-teilig, 24,8 x 24,8 cm

HS 10 700410
5-teilig, 13,9 x 15,2 cm

HS 11 700411
5-teilig, 10,8 x 12,7 cm

HS 12 700412
5-teilig, 10,8 x 16,8 cm

HS 13 700413
5-teilig, 10,8 x 10,8 cm

HS 14 700414
9-teilig, 17,1 x 17,1 cm

HS 15 700415
9-teilig, 16,5 x 16,5 cm

HS 16 700416
7-teilig, 10,8 x 16,5 cm

HS 17 700417
11-teilig, 24,1 x 16,5 cm

HS 1 700401
3-teilig, 15,2 x 9,8 cm

HS 2 700402
3-teilig, 17,8 x 8,9 cm

HS 3 700403
3-teilig, 10,1 x 11,4 cm

HS 4 700404
3-teilig, 10,8 x 10,5 cm

HS 5 700405
3-teilig, 12,0 x 12,7 cm

HS 6 700406
3-teilig, 11,4 x 11,4 cm

HS 7 700407
3-teilig, 15,2 x 13,9 cm

HS 8 700408
5-teilig, 13,9 x 16,5 cm

HS 9 700409
3-teilig, 13,9 x 13,3 cm

Facetten Bevels

Biseles de espejo y de vidrio

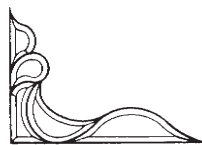

HC 13L 700465
5-teilig, 27,3 x 39,3 cm

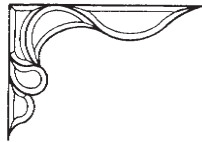

HC 13R 700466
5-teilig, 27,3 x 39,3 cm



HC 14L 700467
8-teilig, 27,9 x 40,0 cm



HC 14R 700468
8-teilig, 27,9 x 40,0 cm

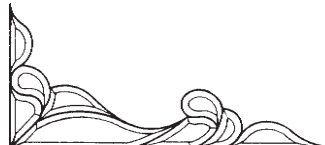

HC 15L 70046469
9-teilig, 29,2 x 64,8 cm



HC 15R 700470
9-teilig, 29,2 x 64,8 cm



HN 1 700471
6-teilig, 15,2 x 12,7 cm



HN 2 700472
9-teilig, 22,7 x 21,6 cm



HN 3 700473
11-teilig, 25,4 x 24,1 cm



HN 4 700474
9-teilig, 17,8 x 15,4 cm



HN 5 700475
12-teilig, 20,3 x 22,9 cm



HN 6 700476
16-teilig, 22,9 x 24,1 cm



HN 7 700477
7-teilig, 17,8 x 22,9 cm



HS 39 700439
16-teilig, 30,5 x 15,2 cm

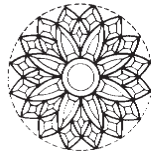

HS 40 700440
25-teilig, 30,5 x 30,5 cm

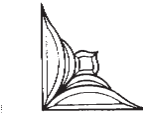

HC 5 700455
5-teilig, 22,2 x 22,2 cm



HC 6 700456
4-teilig, 22,9 x 22,9 cm



HC 7 700457
3-teilig, 13,3 x 13,3 cm



HC 8 700458
6-teilig, 21,6 x 21,6 cm

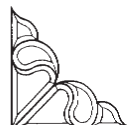

HC 9 700459
6-teilig, 25,4 x 25,4 cm

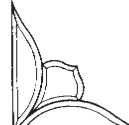

HC 10 700460
3-teilig, 27,9 x 27,9 cm



HC 11L 700461
4-teilig, 18,4 x 25,4 cm



HC 11R 700462
4-teilig, 18,4 x 25,4 cm



HC 12L 700463
3-teilig, 20,3 x 40,0 cm

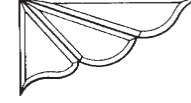

HC 12R 700464
3-teilig, 20,3 x 40,0 cm

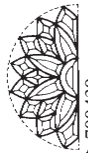

HC 1 700451
2-teilig, 17,8 x 17,8 cm



HC 2 700452
3-teilig, 17,8 x 17,8 cm



HC 3 700453
4-teilig, 21,0 x 21,0 cm



HC 4 700454
3-teilig, 21,0 x 21,0 cm

HINWEIS Die HC-Bevels sind ca. im Maßstab 10 : 1 abgebildet.

Sie bestehen aus 5 mm Floatglas und haben einen umlaufenden Facettenschiff von 12 mm.



HN 24 700494
7-teilig, 10,2 x 25,7 cm



HN 25 700495
3-teilig, 8,3 x 8,3 cm

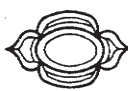

HG 1 700501
5-teilig, 16,5 x 27,9 cm



HG 2 700502
5-teilig, 9,5 x 19,0 cm



HG 3 700503
7-teilig, 15,9 x 27,3 cm



HG 4 700504
5-teilig, 17,8 x 28,6 cm



HG 5 700505
5-teilig, 19,0 x 19,0 cm



HG 6 700506
11-teilig, 26,7 x 36,8 cm



HG 7 700507
12-teilig, 37,5 x 29,2 cm



HG 8 700508
8-teilig, 15,2 x 30,5 cm



HG 9 700509
4-teilig, 15,2 x 24,1 cm



HG 10 700510
10-teilig, 34,3 x 25,4 cm



HG 11 700511
7-teilig, 18,4 x 38,1 cm



HG 12 700512
11-teilig, 22,9 x 34,3 cm

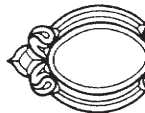

HG 13 700513
13-teilig, 22,9 x 39,4 cm

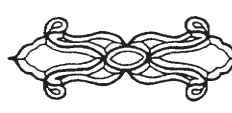

HG 14 700514
11-teilig, 17,8 x 50,8 cm

HINWEIS
Die HG-Bevels sind ca. im
Maßstab 10 : 1 abgebildet.

Sie bestehen aus 5 mm Floatglas
und haben einen umlaufenden
Facettenschliff von 12 mm.



HN 8 700478
7-teilig, 17,8 x 36,8 cm



HN 9 700479
7-teilig, 17,8 x 22,9 cm



HN 10 700480
11-teilig, 20,3 x 22,9 cm



HN 11 700481
5-teilig, 13,3 x 27,3 cm

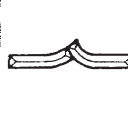

HN 12 700482
2-teilig, 6,4 x 27,9 cm

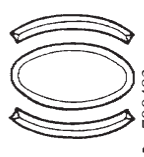

HN 13 700483
3-teilig, 25,4 x 27,9 cm



HN 14 700484
20-teilig, 40,6 x 40,6 cm



HN 15 700485
5-teilig, 17,8 x 16,5 cm



HN 16 700486
6-teilig, 19,1 x 33,0 cm



HN 17 700487
9-teilig, 20,3 x 25,4 cm



HN 18 700488
10-teilig, 17,8 x 29,2 cm



HN 19 700489
10-teilig, 22,9 x 24,1 cm

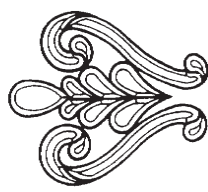

HN 20 700490
15-teilig, 35,6 x 42,0 cm



HN 21 700491
6-teilig, 16,5 x 16,5 cm



HN 22 700492
6-teilig, 12,7 x 12,7 cm



HN 23 700493
4-teilig, 10,2 x 16,5 cm

HINWEIS Die HN-Bevels sind ca. im Maßstab 10 : 1 abgebildet. Sie bestehen aus
5 mm Floatglas und haben einen umlaufenden Facettenschliff von 12 mm.

Facetten
Biseles de espejo y de vidrio
Bevels

Facetten Bevels

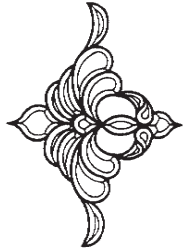

HG 29 700529
14-teilig, 50,8 x 28,6 cm



HG 30 700530
18-teilig, 56,5 x 42,0 cm

HINWEIS
Die F-Bevels sind ca. im
Maßstab 1 : 1 abgebildet.

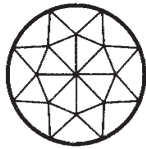

F 61 700556
1-teilig, Ø 2,5 cm
6 mm stark

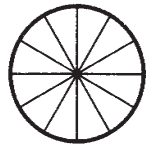

F 51 700553
1-teilig, Ø 2,5 cm
6 mm stark

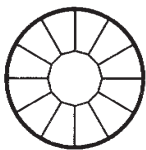

F 41 700550
1-teilig, Ø 2,5 cm
5 mm stark



F 615 700557
1-teilig, Ø 3,8 cm
8 mm stark

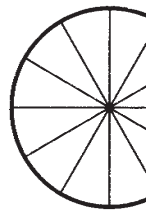

F 515 700554
1-teilig, Ø 3,8 cm
6 mm stark



F 415 700551
1-teilig, Ø 3,8 cm
5 mm stark

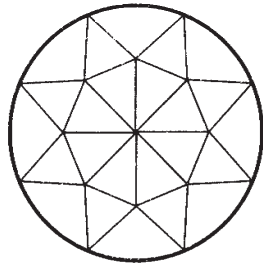

F 62 700558
1-teilig, Ø 5,1 cm
8 mm stark

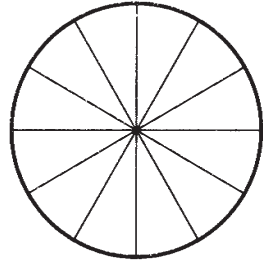

F 52 700555
1-teilig, Ø 5,1 cm
6 mm stark

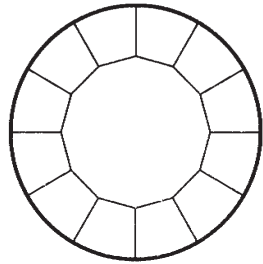

F 42 700552
1-teilig, Ø 5,1 cm
5 mm stark

HINWEIS
Die F-Bevels sind ca. im Maßstab
1 : 1 abgebildet.

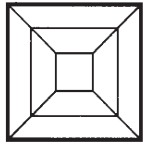

F 31 700547
1-teilig, 2,5 x 2,5 cm
6 mm stark

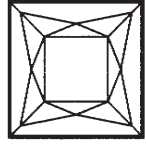

F 21 700544
1-teilig, 2,5 x 2,5 cm
8 mm stark

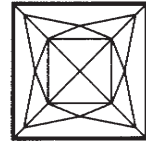

F 11 700541
1-teilig, 2,5 x 2,5 cm
8 mm stark

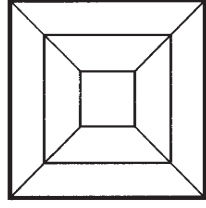

F 315 700548
1-teilig, 3,8 x 3,8 cm
6 mm stark

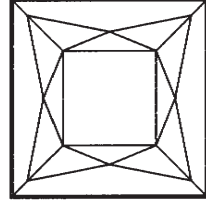

F 215 700545
1-teilig, 3,8 x 3,8 cm
8 mm stark

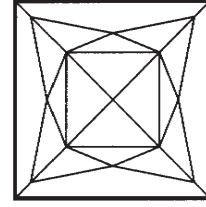

F 115 700542
1-teilig, 3,8 x 3,8 cm
8 mm stark

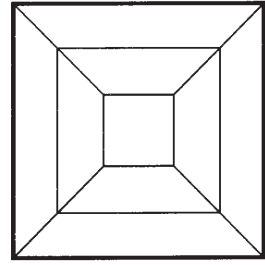

F 32 7005549
1-teilig, 5,1 x 5,1 cm
6 mm stark

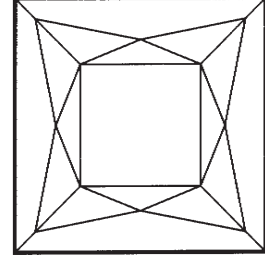

F 22 700546
1-teilig, 5,1 x 5,1 cm
8 mm stark

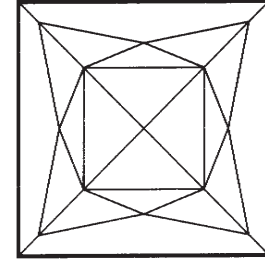

F 12 700543
1-teilig, 5,1 x 5,1 cm
8 mm stark

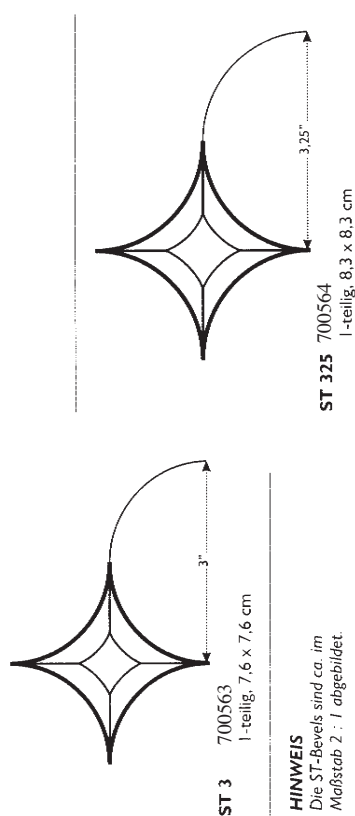
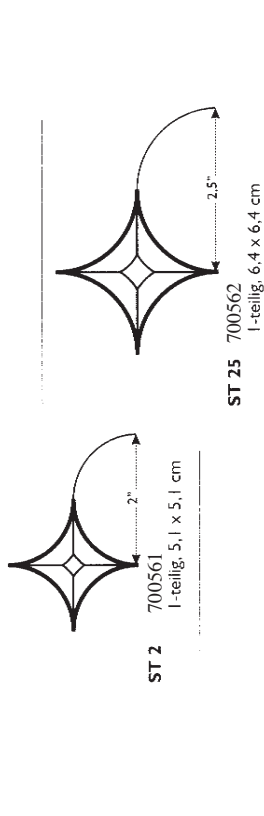

HINWEIS
Die ST-Bevels sind ca. im Maßstab 2 : 1 abgebildet.
Sie bestehen aus 5 mm Floatglas und haben einen umlaufenden Facettenschliff von 12 mm.

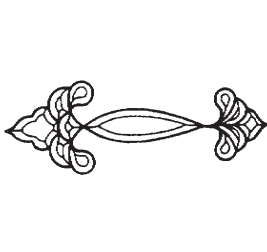
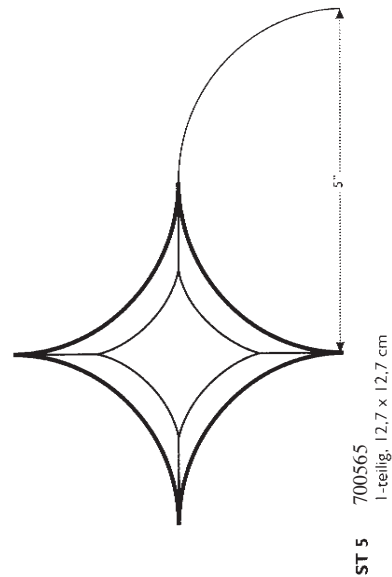

HG 15 700515
12-teilig, 19,1 x 54,6 cm

HG 20 700520
12-teilig, 25,4 x 39,4 cm

HG 25 700525
15-teilig, 18,4 x 52,1 cm



HG 21 700521
11-teilig, 26,7 x 26,7 cm



HG 16 700516
6-teilig, 21,6 x 21,6 cm

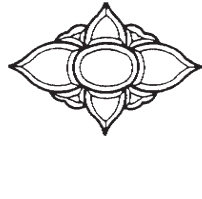

HG 26 700526
9-teilig, 29,2 x 43,2 cm



HG 22 700522
13-teilig, 31,1 x 29,2 cm



HG 17 700517
9-teilig, 17,8 x 26,0 cm



HG 23 700523
6-teilig, 18,4 x 29,2 cm



HG 18 700518
6-teilig, 21,6 x 21,6 cm



HG 27 700527
9-teilig, 17,8 x 38,1 cm

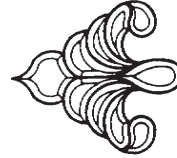

HG 24 700524
10-teilig, 31,1 x 36,8 cm

HG 28 700528
8-teilig, 15,9 x 34,3 cm



HG 19 700519
14-teilig, 21,6 x 39,4 cm

Facetten Bevels

Biseles de espejo y de vidrio

Facetten Bevels



HF 1 700571
8-teilig, 21,6 x 43,5 cm



HF 2 700572
8-teilig, 19,0 x 38,1 cm



HF 3 700573
8-teilig, 17,8 x 38,1 cm



HF 4 700574
5-teilig, 15,2 x 39,4 cm



HF 5 700575
7-teilig, 15,2 x 32,0 cm



HF 6 700576
7-teilig, 19,0 x 38,1 cm



HF 7 700577
5-teilig, 17,8 x 36,8 cm



HF 8 700578
5-teilig, 13,8 x 30,5 cm



HF 9 700579
9-teilig, 17,1 x 36,8 cm



HF 10 700580
5-teilig, 14,0 x 38,1 cm



700566
5,1 x 5,1 cm



700567
6,5 x 6,5 cm



700568
11,0 x 11,0 cm



700569
4" x 6" x 1"



700570
6" x 8" x 1"

HINWEIS
Die HF-Bevels sind ca. im
Maßstab 10 : 1 abgebildet.
Sie bestehen aus 5 mm Floatglas
und haben einen umlaufenden
Facettenschliff von 1,2 mm.